

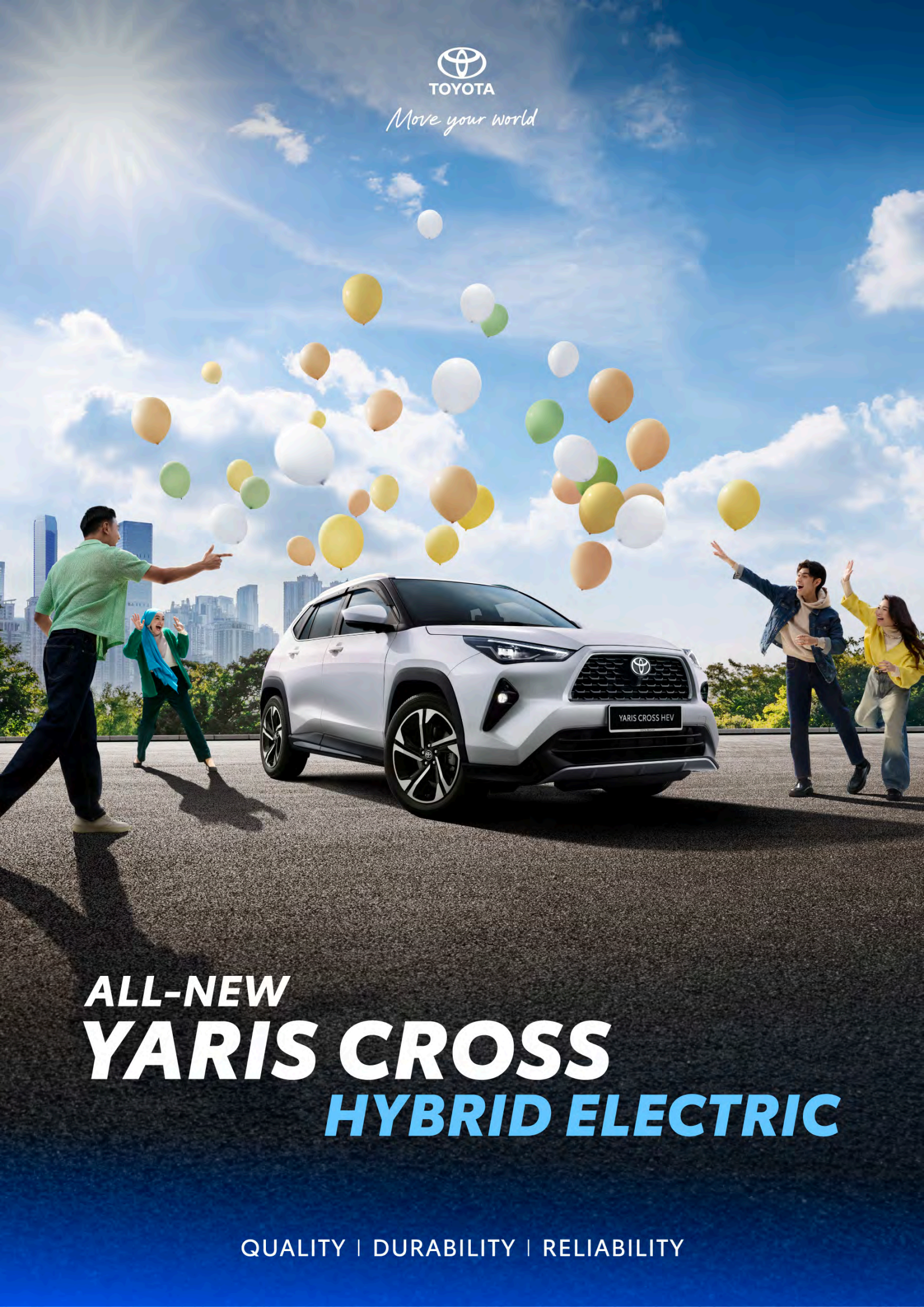

TOYOTA

Move your world



ALL-NEW
YARIS CROSS
HYBRID ELECTRIC

QUALITY | DURABILITY | RELIABILITY



BEYOND ZERO



**YOUR PATH
YOUR WAY**

TOYOTA HYBRID ELECTRIC SYSTEM

Delivering maximum efficiency, advanced tech, and a greener future - all in one.



1 Fuel Efficiency

Go further on every drive with an impressive average fuel consumption of up to 27.8 km/L. Designed to maximise efficiency without compromising performance, so you spend less time refuelling and more time moving.



2 Year-round Reliability

Drive confidently with an 8-year unlimited mileage warranty on key hybrid components, keeping your vehicle consistently reliable for years to come.

Optional: Extension for years 9 and 10 available.



3 Better Emissions

Yaris Cross Hybrid
Electric CO₂ Emissions: **84** g/km

Toyota's hybrid system helps create a cleaner, more sustainable future through less petrol usage and reduced carbon footprint.



4 Regenerative Braking

Toyota's self-charging hybrid system channels energy from braking into recharging the battery, keeping you powered without wasting energy.



5 Handling Stability

Engineered for better stability and ride comfort. With a lower centre of gravity through the strategic placement of the hybrid system.

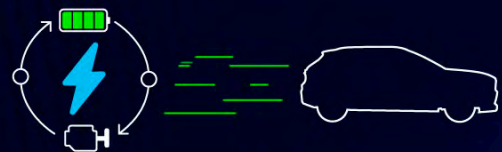

6 Dual Power

Experience the best of both worlds where electric efficiency meets petrol power to improve performance and elevate every drive with effortless control.

4TH GENERATION HYBRID ELECTRIC SYSTEM

The All-New Yaris Cross Hybrid Electric blends electric and petrol power for a smooth, fuel-efficient drive. Experience responsive acceleration, whisper-quiet operation, and lower emissions everywhere you go.



EFFICIENT PETROL ENGINE

POWERFUL ELECTRIC MOTORS

HIGH-PERFORMANCE HYBRID ELECTRIC BATTERY

1 Battery powers car

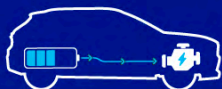

START/LOW SPEED

Only the motor powers the whole car with electricity from the Hybrid Electric battery.*

2 Battery is charged

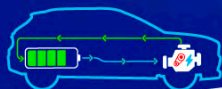

NORMAL DRIVING

The engine and motor power the car together while the Hybrid Electric battery is charged.

3 Dual power for quicker acceleration

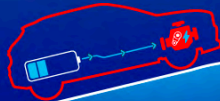

HARD ACCELERATION

Petrol engine and electric motor provide maximum power together with supplemental electrical power from the HEV battery to the motor.

4 Braking charges battery

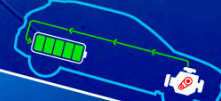

BRAKING

The energy generated from braking recharges the battery.

5 Engine auto off

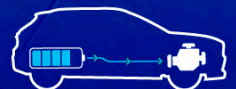

STOPPED

The engine turns off automatically when idle to prevent unnecessary petrol consumption.

*Toyota Hybrid Electric System will charge the Hybrid Electric battery automatically depending on the driving condition, weather, and Hybrid Electric battery state of charge.

PERFORMANCE

CONFIDENCE IN MOTION

Designed to move with playful confidence, the All-New Yaris Cross delivers smooth, responsive performance, turning every drive into an effortlessly joyful experience.



1.5L 2NR-VEX DOHC + DUAL VVT-I ENGINE

Smooth, quiet, and responsive, the 1.5L 2NR-VEX DOHC + Dual VVT-i engine delivers effortless performance. With outstanding fuel efficiency of just ***3.6L/100km**, class-leading low CO₂ emissions, and no extra maintenance required, every drive is efficient, confident, and carefree.

**Based on NEDC (Combined).*

91ps
Max. Output

121Nm
Max. Torque



1.5L 2NR-VE DOHC + DUAL VVT-I ENGINE

Balancing improved fuel efficiency with sharper throttle response, this compact and reliable engine brings a spirited touch to every drive — effortlessly confident, every time.

106ps
Max. Output

138Nm
Max. Torque



PERFORMANCE

CONFIDENCE IN MOTION



EV MODE / DRIVE MODE

Experience silent, emission-free electric driving in selected conditions, with the EV Driving Ratio Display giving you a clear view of your efficiency every step of the way.



BEST-IN-CLASS TURNING RADIUS

Navigate the city and suburbs easily with the best turning radius in its class.

EXTERIOR

PLAYFUL BOLDNESS

A smartly sculpted cabin maximises space, while wide-set wheels give it a confident SUV stance. Strong lines and bold proportions bring dynamic energy to a design that is both playful and poised.



SOLID DYNAMIC DESIGN

A bold trapezoidal stance and sculpted grille design give the All-New Yaris Cross a planted, forward-moving presence. Sharp contours and confident proportions create a look that is dynamic yet assured.



18" ALLOY RIMS

18" 2-tone machined alloy wheels.



LED HEADLAMPS

A sleek, confident design that stands out with unmistakable brightness and clearer visibility on the road.



ROOF RAILS

Providing ample space to attach extra-large cargo without compromising the interior cabin space.

EXTERIOR

PLAYFUL BOLDNESS



SPACIOUS BOOT SPACE

Enjoy generous luggage space that fits various types of loads. For the All-New Yaris Cross, the repositioning of the Hybrid Electric battery allows the boot space to be uncompromised.



LED REAR COMBINATION LAMPS

Distinctive light curtain tail lamps deliver a sharp, uniform glow - elevating visibility and accentuating the vehicle's modern design.



16" SPARE TYRE

A 16" spare tyre, ready when you need it.



OUTER MIRROR FOOT LAMP

The Outer Mirror Foot Lamp lights your path and welcomes you in. Activated automatically with the Smart Entry & Start System key, it switches on as you approach and fades off as you leave.

EXTERIOR

PLAYFUL BOLDNESS

KICK-SENSOR POWER BACK DOOR

Automatically open and close the back door by performing a kick motion under the rear bumper.

SECURITY

ASSURED CONFIDENCE

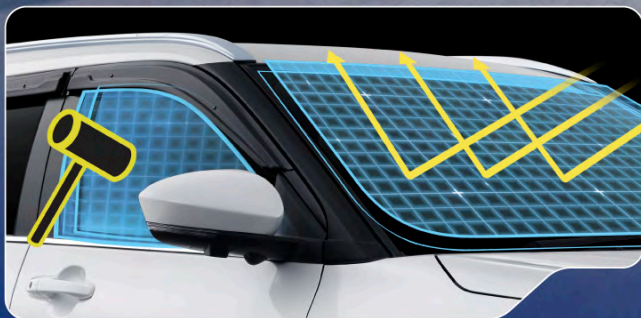

SECURITY SOLAR FILM

Solar Security Film enhances security, blocks harmful rays, and minimises cabin heat — creating a safer, cooler, and more comfortable drive.

COLOURS

Dark Turquoise



Silver Metallic



Attitude Black



Spicy Scarlet SE



Platinum Pearl White



INTERIOR

PLAYFUL COMFORT

A wide, soft-padded dashboard blends into the door trim to create a sporty, spacious SUV cabin. Premium soft-touch surfaces and satin accents enhance comfort while reinforcing a refined, performance-inspired interior.



DRIVER-ORIENTED COCKPIT

Designed around the driver, the meter-focused cockpit reinforces a dynamic, performance-inspired atmosphere.

INTERIOR ILLUMINATION

Blue illumination on the console box and front door trim creates a refined, modern ambience, with adjustable brightness across four levels.



AUTO AIR-CONDITIONING

The auto air-conditioning and auto cooler systems are available to provide a high-quality appearance, excellent legibility and intuitive operability.



ELECTRONIC PARKING BRAKE

Pull up the Electronic Parking Brake (EPB) while pressing the brake pedal to keep your parked car stationary, then push down to release. The Hold button next to it holds your position and releases automatically when you move, making every drive smoother and more intuitive.



7" TFT LCD DISPLAY & DIGITAL LED SPEEDOMETER

A seamless 7" TFT display paired with a digital LED speedometer creates a bold, full-screen-inspired look. Select from four display modes to suit your style when the vehicle is stopped.

INTERIOR

PLAYFUL COMFORT



REAR AIR CONDITIONING WITH USB-C CHARGING PORTS

Access to air conditioning vents and rear USB ports keep passengers comfortable and connected throughout the journey.

BLUE ACCENT COLOUR STITCHING

Distinctive blue detailing on the dashboard and seat stitching adds a refined yet sporty character to the interior.



DRIVER SEAT WITH 8-WAY POWER ADJUSTER

With a simple push of a button, the driver can customise their seating position for maximum comfort and support.



ILLUMINATED SCUFF PLATE*

A refined, illuminated scuff plate with the Yaris Cross name that adds a premium touch while protecting your door sills.

**For HEV variant only.*

SAFETY

CONFIDENTLY PROTECTED

Designed for complete peace of mind, advanced safety technologies work seamlessly in the background, so you can drive with playful confidence on every journey.

360-T ADVANCED

It's all about Trust & Technology by Toyota



SAFE-T Trust for smoother journeys ahead



3D PANORAMIC VIEW MONITOR (PVM)

Get a detailed 360° view of your vehicle for manoeuvring in tight spaces.



BLIND SPOT MONITOR (BSM) WITH REAR CROSS TRAFFIC ALERT (RCTA)

Monitors areas you cannot easily see and alerts you to approaching vehicles when changing lanes or reversing.



FRONT & REAR DIGITAL VIDEO RECORDER (DVR)*

Provides convenient access and monitoring via Toyota DVR app.

**Rear DVR is an optional accessory.*



6 SRS AIRBAGS

Six strategically placed airbags help safeguard occupants by absorbing and dispersing collision energy in a severe crash.



HILL-START ASSIST CONTROL (HAC)

Sustains brake pressure for 3 seconds to prevent the vehicle from rolling backwards on an incline.



FRONT & REAR SONAR SYSTEM

Front and rear parking sensors detect nearby objects and vehicles, providing timely alerts to help you park safely and with greater ease.

SAFE-T Trust for smoother journeys ahead



PRE-COLLISION SYSTEM (PCS)*

Avoids or mitigates frontal collisions by alerting the driver and automatically applying the brakes when there is a risk of collision.



LANE DEPARTURE WARNING (LDW)*

Alerts and assists when you are out of the lane unintentionally. Less swaying, smoother driving.



ADAPTIVE CRUISE CONTROL (ACC)*

Detects speed and distance of vehicles in front to automatically adjust and maintain speed from a safe following distance.



LANE DEPARTURE PREVENTION (LDP)*

Automatically corrects steering to help the driver keep the vehicle within the lane. The driver receives alerts via the display and audio buzz.



AUTOMATIC HIGH BEAM (AHB)*

Automatically switches between high beam and low beam as needed to provide maximum road visibility.



PEDAL MISOPERATION CONTROL*

Design to help avoid or mitigate damage from a forward collision.

**Driver remains solely responsible at all times for safe driving.*

Toyota
Safety
Sense

CONNECTIVI-T

Technology at your command



10.1" DISPLAY AUDIO WITH WIRELESS AACAP CONNECTIVITY*

Connect your smartphone wirelessly to the multimedia display for calls, music, and navigation. With Apple CarPlay® and Android Auto™, enjoy a convenient and personalised driving experience.



WIRELESS CHARGER

Offers convenient charging for Qi** standard-compliant devices, without the use of a cable.

*Note: Standard for 1.5S HEV.
Optional for 1.5S.*



VEHICLE TELEMATICS SYSTEM (VTS)

An integrated system that monitors and shares your vehicle's real-time location through a mobile app.

GUARAN-T

Total peace of mind



5 years vehicle warranty from the date of first registration with unlimited mileage.

Terms and conditions apply.



8 years warranty from the date of first registration with unlimited mileage covering the Hybrid Electric Vehicle (HEV) battery, inverter and power management control ECU. Optionally, this Hybrid Electric warranty can be extended for another 2 years (9th & 10th year).

Terms and conditions apply.

**Android Auto™ functions may vary depending on smartphone model. **International standard for wireless charging developed by Wireless Power Consortium.*

SPECIFICATIONS

ENGINE		1.5S	1.5S HEV
Model		2NR-VE	2NR-VEX
Type		4-cylinder, In-line, 16-valve DOHC with Dual-VVT-i	
Displacement	cc	1,496	
Bore x Stroke	mm	72.5 x 90.6	
Engine Power	kW (PS) / rpm	78 (106) / 6,000	67 (91) / 5,500 (Engine)
Engine Torque	Nm / rpm	138 / 4,200	121 / 4,000 - 4,800
Electric Motor Power	kW (PS)	-	59 (80)
Electric Motor Torque	Nm	-	141
Combined Output	kW (PS)	-	82 (111)

TRANSMISSION

Type	7-speed CVT with Sequential Shiftmatic	e-CVT
------	--	-------

CHASSIS

Suspension	Front / Rear	Macpherson Strut with Stabiliser / Torsion-Beam with Stabiliser
Brakes	Front / Rear	Disc / Disc
Tyres & Rims		215/55 R18 Alloy (Machining)
Spare Tyre & Rim		195/65 R16

DIMENSIONS

Overall	Length	mm	4,310
	Width	mm	1,770
	Height	mm	1,615 / 1,655 (inc.antenna)
Wheelbase	mm		2,620
Kerb Weight	kg	1,150	1,245
Fuel Tank Capacity	litre	42	36
Minimum Turning Radius	m		5.2
Ground Clearance	m		210
Cargo Space	litre	471	465

EXTERIOR

Headlamps	Type	LED
	Levelling	Manual
	Additional Feature(s)	Daytime Running Lights (DRL) / Clearance Lamp
Fog Lamps		LED
Rear Tail Lamps		LED
Wing Mirrors		Auto Retractable, Signal Lamps, BSM Indicators & Welcome Light
Antenna		Shark Fin
Roof Rail		With
Door Visors		With

DIMENSIONS

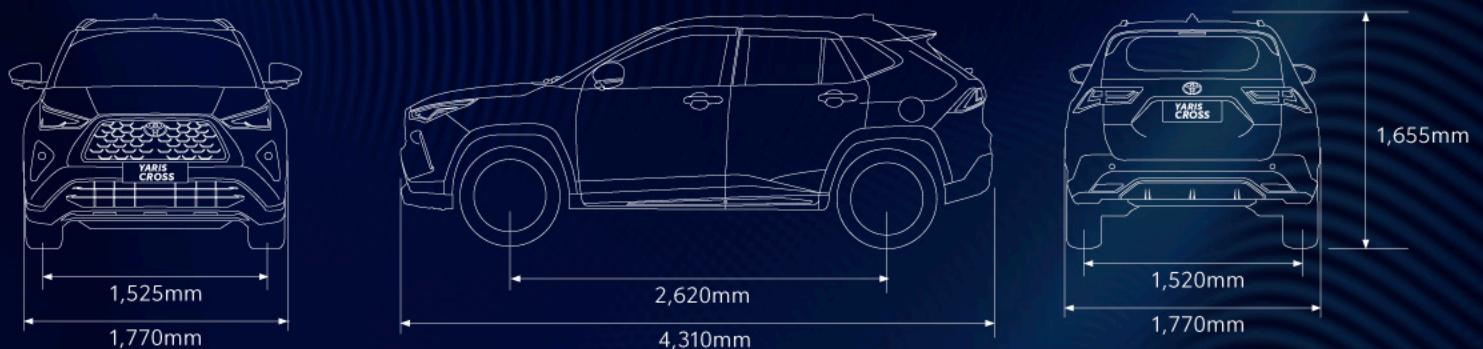

SPECIFICATIONS

INTERIOR		1.5S	1.5S HEV
Smart Entry and Start System		With	
Drive Mode Switch		Power, Eco & Normal Mode	
Meter Combination		Segment Negative LCD & Digital Speedometer	
Multi-Information Display (MID)		7" Colour Display	
Air Conditioning	Front	Automatic	
	Rear	With	
Steering Wheel	Type	3-spoke Leather with Tilt & Telescopic Adjustable	
	Control Switches	Audio, Meter, Talk, Telephone, Adaptive Cruise Control, LKC, Drive Mode	
Gear Shift Lever		Leather	
Paddle Shifter		With	-
Power Windows		Front and Rear with Auto Up/Down & Jam Protection (Driver Only)	
Audio	Type	Display Audio with 10.1" Capacitive Touch Screen, Wired / Wireless Apple CarPlay® & Android Auto Connectivity™, USB & Bluetooth®	
	Speakers	Speakers x4 + Tweeters x2	
Interior Colour & Trim		Black with Soft Pad	
Seats	Material / Colour	Black Leather	Black Leather with Perforation
	Driver Seat	Power seat	
	Front Passenger Seat	Manual	
	Rear Seat	6:4 Tumble Slide, Foldable Armrest with Cup Holders	
Inside Rear View Mirror		With	
Sun Shades		With Mirror, LED Lamp & Holder (Driver), with Mirror & LED Lamp (Passenger)	
USB Charging Ports (USB-C)		Console (Rear x2)	
Accessory Socket (12V)		1	
Wireless Charger		-	With
Cup/Bottle Holders		4	
Illuminated Entry System		With (Push Start & Room)	
Interior Ambient Lighting		With (Centre Console & FR Door Trims)	
Illuminated Scuff Plate		-	With
Front Leg Room Lamp		-	With
Lamps		With LED (Map, Center, Luggage Compartment)	
3D Panoramic View Monitor (PVM)		With	
Digital Video Recorder (DVR) - Front		With	
Carpet Mat		With	
Power Back Door with Kick Sensor		With	
SAFETY			
ACTIVE			
Toyota Safety Sense			
Pre-Collision Warning (PCW)		With	
Pre-Collision Braking (PCB)		With	
Pre-Collision Braking Assist (PCBA)		With	
Adaptive Cruise Control (ACC) with Full Speed Range		With	
Lane Departure Warning (LDW)		With	
Lane Departure Prevention (LDP) with Steering Assist		With	
Lane Keeping Control (LKC)		With	
Front Departure Alert		With	
Auto High Beam (AHB)		With	

SPECIFICATIONS

SAFETY	1.5S	1.5S HEV
ACTIVE		
Surrounding Monitoring System		
Blind Spot Monitor (BSM)		With
Rear Cross Traffic Alert (RCTA)		With
Parking Assist		
Pedal Misoperation Control (Front)		With
Parking Sensors		With (Front x2 & Rear x2)
Vehicle Stability Control (VSC) & Traction Control (TRC)		With
Anti-lock Braking System (ABS)	With Electronic Brake-force Distribution (EBD) & Brake Assist (BA)	
Hill-start Assist Control (HAC)		With
Emergency Stop/Brake Signal (ESS)		With
Parking Brake		Electric Parking Brake (EPB)
Auto Brake Hold		With
PASSIVE		
SRS Airbags	6 Airbags (Driver, Front Passenger, Side & Curtain)	
Seat Belts	Driver, Front Passenger, Rear Passenger	
Warning	Driver, Front Passenger, Rear Passenger	
Front	3-Point ELR x 2 with Pretensioner and Force Limiter	
Rear	3-Point ELR x3	
Seat Belt Warning	All seats	
ISOFIX	With (Rear x2)	
SECURITY		
Alarm System	With Immobilizer, Indicator & Alarm	
Vehicle Telematics System (VTS)		With
Security & Solar Film		With
OPTIONAL		
Wireless Charger	Optional	-
Digital Video Recorder (DVR) - Rear		Optional



5 years vehicle warranty from the date of first registration with unlimited mileage. Terms and conditions apply.



8 years warranty from the date of first registration with unlimited mileage covering the Hybrid Electric Vehicle (HEV) battery, inverter and power management control ECU. Optionally, this Hybrid Electric warranty can be extended for another 2 years (9th & 10th year). Terms and conditions apply.



The Yaris Cross has been awarded a 5-star ASEAN NCAP safety rating.



Energy Efficient Vehicle

TOYOTA EXTRA MILE

Toyota prides itself in keeping its cars longer on the road.

But beyond its legendary legacy of durability and reliability is the commitment to go the extra mile for every customer.

With a comprehensive network of services and facilities across Malaysia to make every Toyota ownership more convenient than ever.

From delivery to your doorstep to holistic car maintenance assistance services, simpler ownership cost management, and much more.

We're more than just an automobile company, we're a mobility company committed to 'Move Your World'.

TOYOTA EXTENSIVE SALES & SERVICE NETWORK NATIONWIDE

Conveniently located for easy accessibility to quality service and genuine parts.

Financial Packages

Selection of financing choices to fit your needs and lifestyle.

Insurance Package

Specially tailored to Toyota owners with exclusive benefits and privileges.

247 Road Assist

Dedicated roadside assistance, 24 hours a day, seven days a week. With FREE minor on-the-spot repairs and towing.

Loyal-T

Rewards you for every transaction you make at Toyota. Redeem service vouchers and other exclusive merchandise.

Maxcheck

All inclusive and comprehensive periodic maintenance checks and schedules.

Service Savers

Makes keeping your new Toyota running at its best easy and even more affordable. Choose from 2, 3 or 5 year service packages.

Genuine Parts

Made to Toyota's exacting standards for guaranteed quality, reliability, and durability, that's readily available nationwide.